

Ground Floor

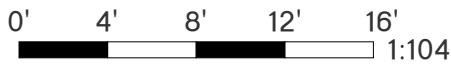
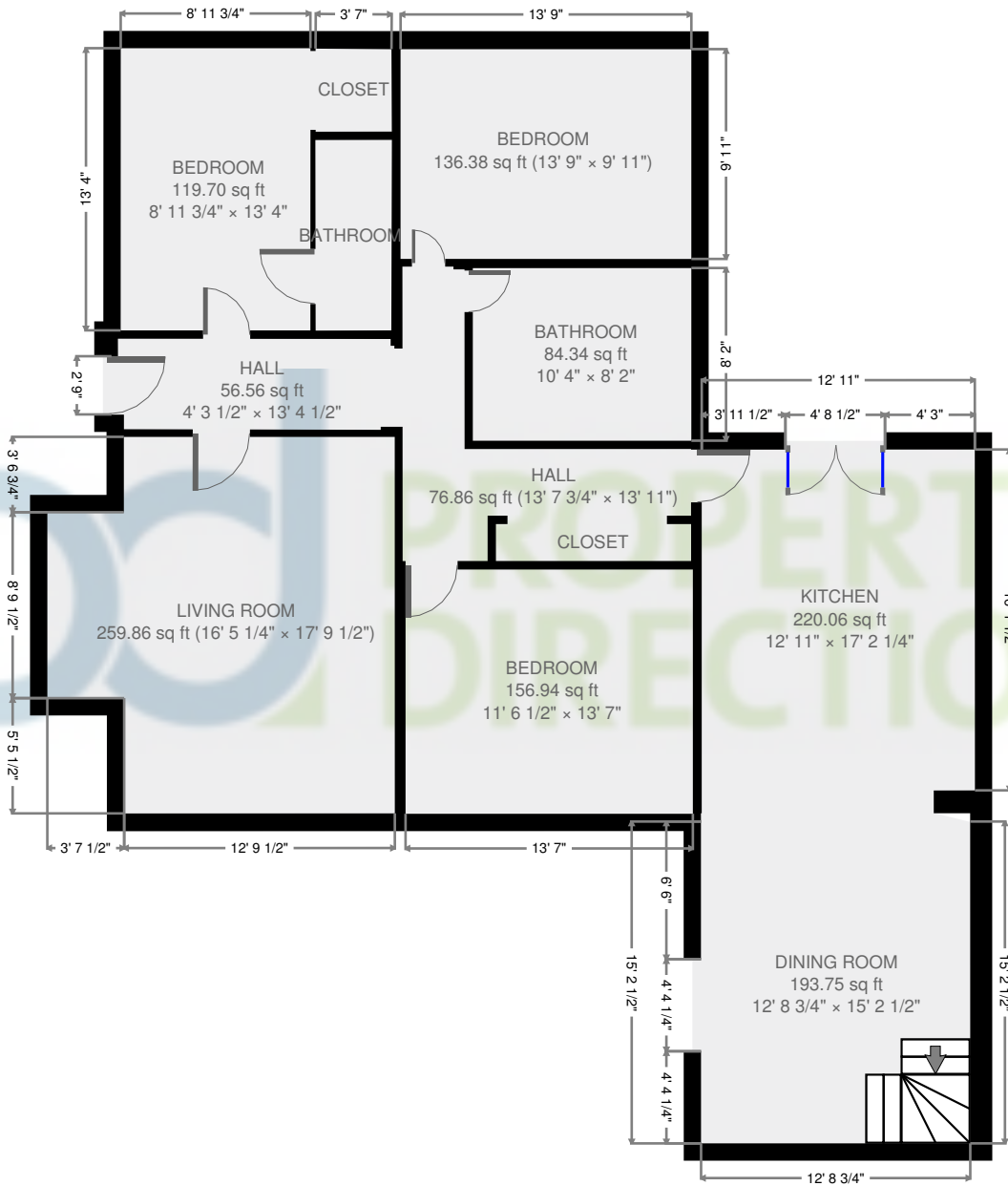

Property Directions.
THIS FLOORPLAN IS PROVIDED WITHOUT WARRANTY OF ANY KIND. SENSOPIA DISCLAIMS ANY WARRANTY INCLUDING, WITHOUT LIMITATION, SATISFACTORY QUALITY OR ACCURACY OF DIMENSIONS.
Property Directions.

16 Shimna Road, Newcastle, BT33 0AT

2016-03-16

1786 sq ft
2 Floors
13 Rooms
4 Bedrooms
3 Bathrooms

Hall

Width: 4' 3 1/2"
 Length: 13' 4 1/2"
 Area: 56.56 sq ft
 Perimeter: 35' 4"
 Ceiling Height: 10' 10 1/4"

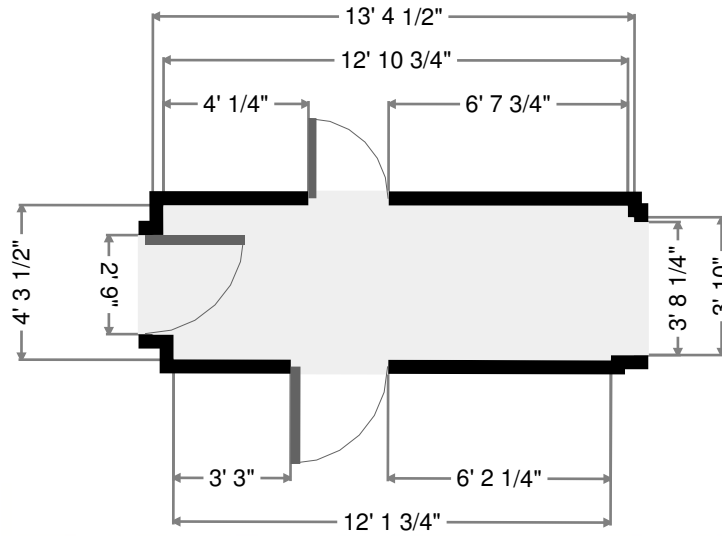
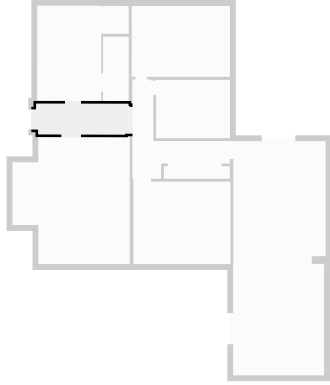

Living Room

Width: 16' 5 1/4"
 Length: 17' 9 1/2"
 Area: 259.86 sq ft
 Perimeter: 68' 5 3/4"
 Ceiling Height: 10' 10 1/4"

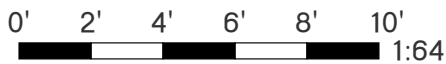
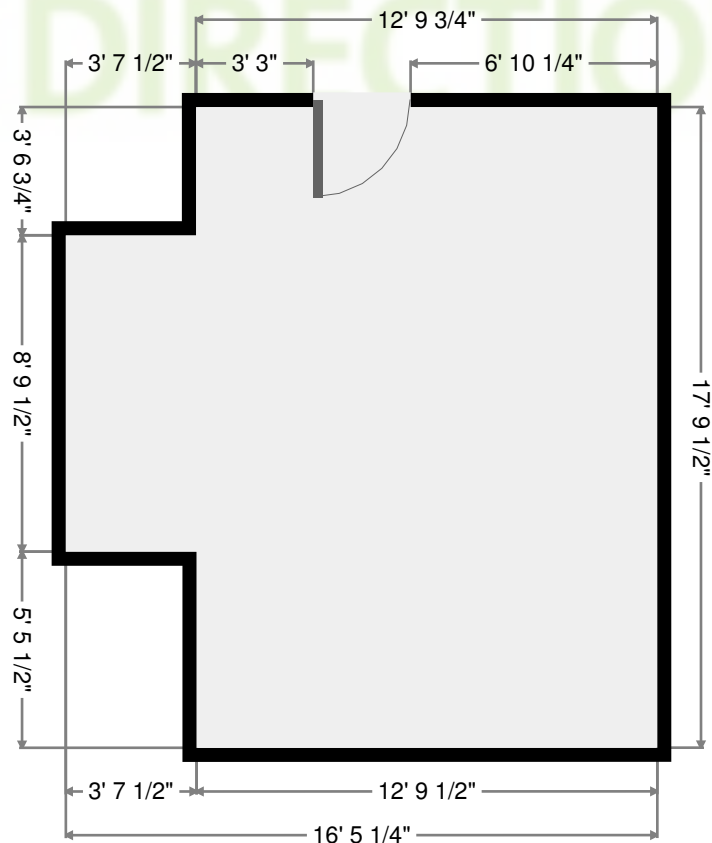
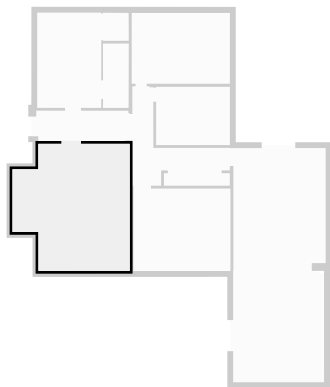

Property Directions. THIS FLOORPLAN IS PROVIDED WITHOUT WARRANTY OF ANY KIND. SENSOPIA DISCLAIMS ANY WARRANTY INCLUDING, WITHOUT LIMITATION, SATISFACTORY QUALITY OR ACCURACY OF DIMENSIONS. Property Directions.

Bedroom

Width: 8' 11 3/4"
 Length: 13' 4"
 Area: 119.70 sq ft
 Perimeter: 44' 7 1/2"
 Ceiling Height: 10' 10 1/4"

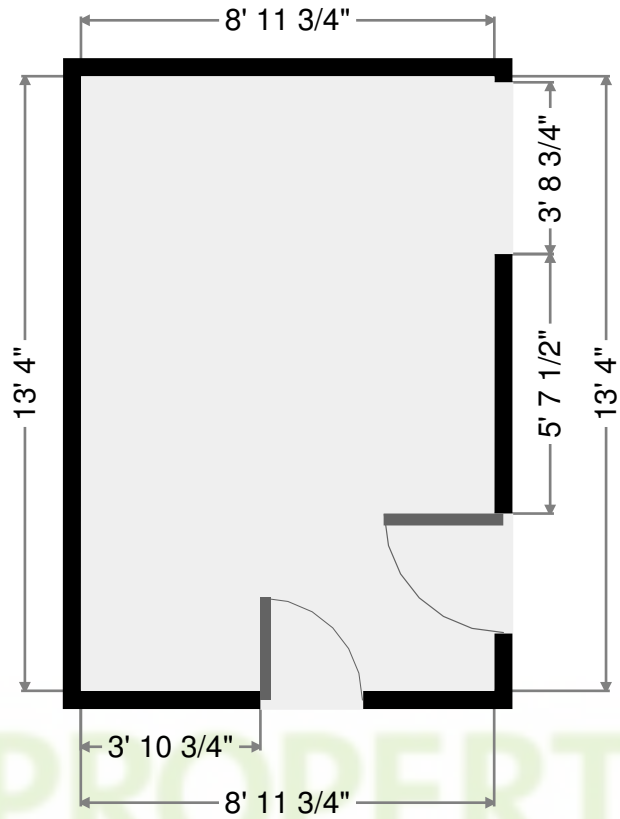
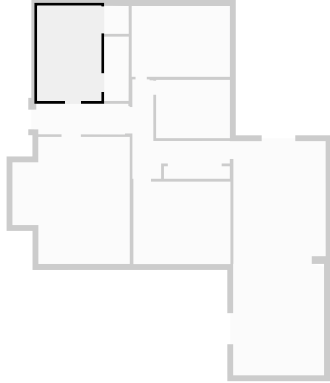

Bedroom

Width: 9' 11"
 Length: 13' 9"
 Area: 136.38 sq ft
 Perimeter: 47' 4"
 Ceiling Height: 10' 10 1/4"

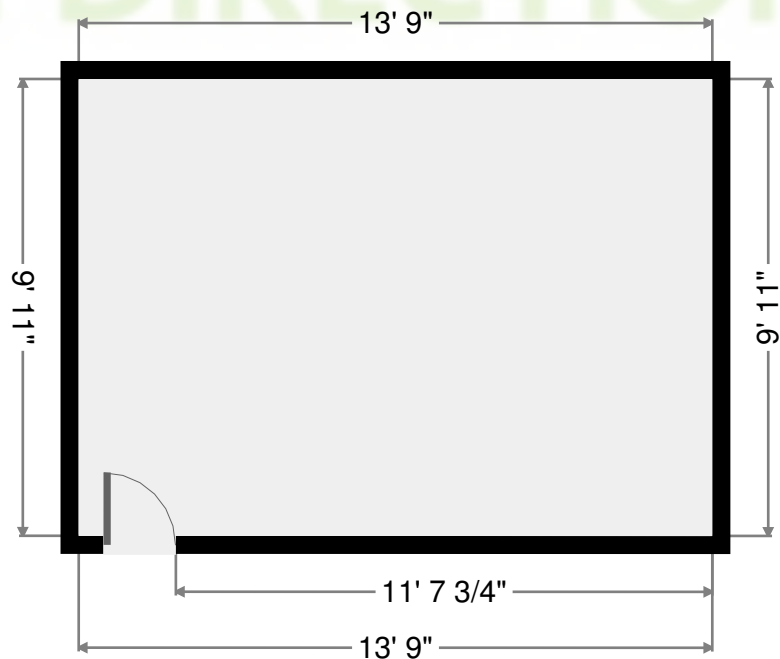
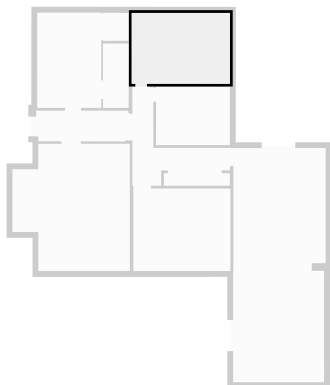

Property Directions. THIS FLOORPLAN IS PROVIDED WITHOUT WARRANTY OF ANY KIND. SENSOPIA DISCLAIMS ANY WARRANTY INCLUDING, WITHOUT LIMITATION, SATISFACTORY QUALITY OR ACCURACY OF DIMENSIONS. Property Directions.

Hall

Width: 13' 7 3/4"
 Length: 13' 11"
 Area: 76.86 sq ft
 Perimeter: 55' 1 1/2"
 Ceiling Height: 10' 10 1/4"

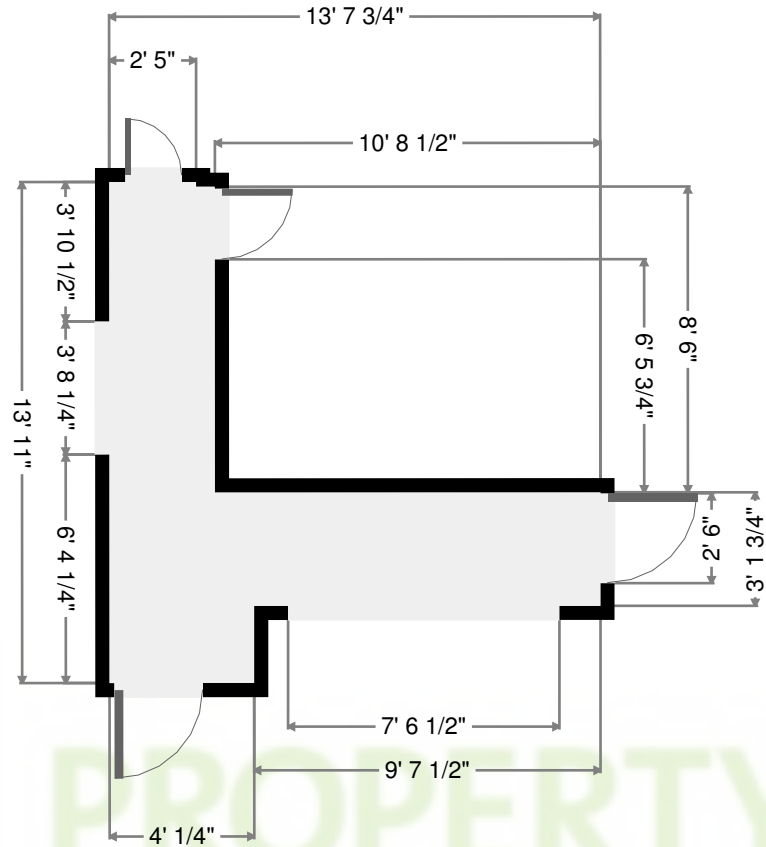
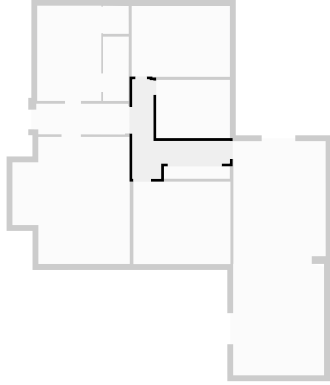

Bathroom

Width: 8' 2"
 Length: 10' 4"
 Area: 84.34 sq ft
 Perimeter: 37'
 Ceiling Height: 10' 10 1/4"

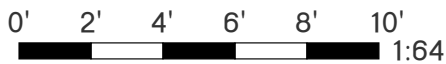
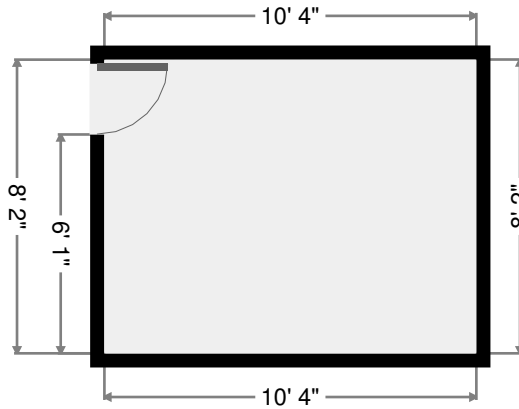
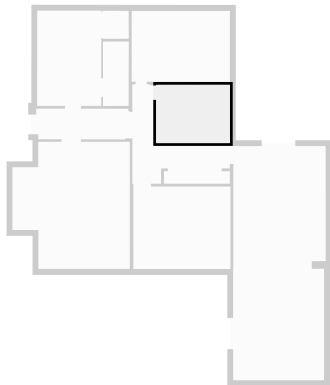

PROPERTY DIRECTIONS

Property Directions. THIS FLOORPLAN IS PROVIDED WITHOUT WARRANTY OF ANY KIND. SENSOPIA DISCLAIMS ANY WARRANTY INCLUDING, WITHOUT LIMITATION, SATISFACTORY QUALITY OR ACCURACY OF DIMENSIONS. Property Directions.

Bedroom

Width: 11' 6 1/2"
 Length: 13' 7"
 Area: 156.94 sq ft
 Perimeter: 50' 3 1/4"
 Ceiling Height: 10' 10 1/4"

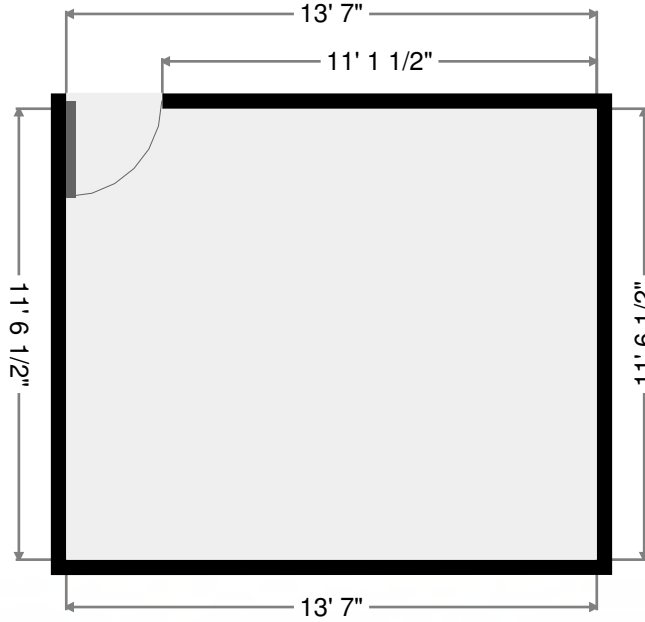
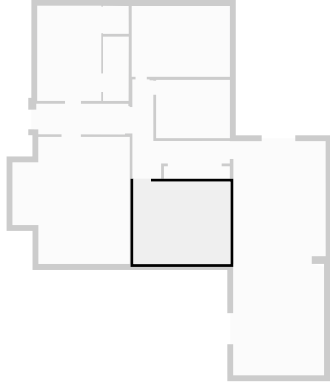

Kitchen

Width: 12' 11"
 Length: 17' 2 1/4"
 Area: 220.06 sq ft
 Perimeter: 60' 2 3/4"
 Ceiling Height: 7' 10 1/2"

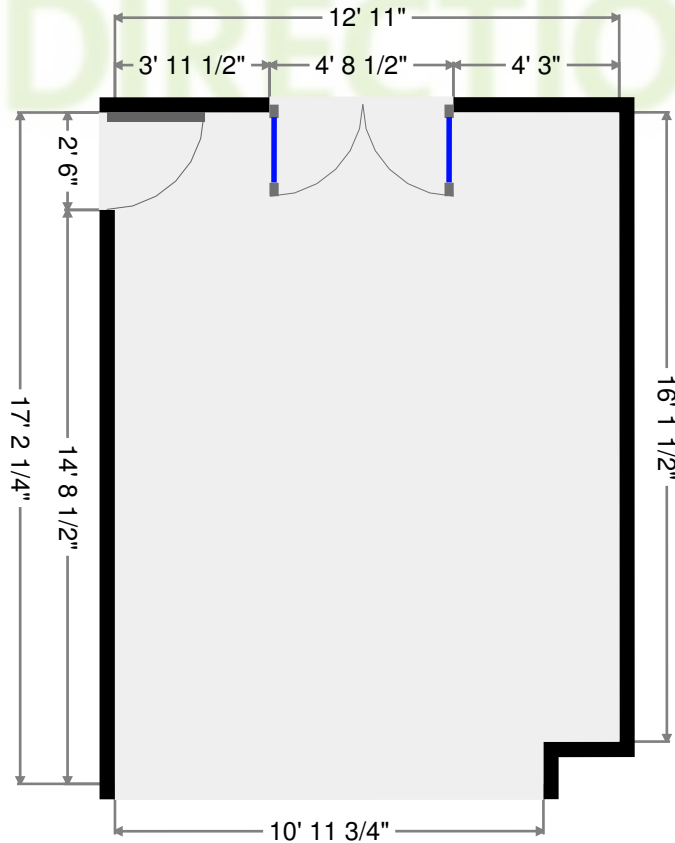
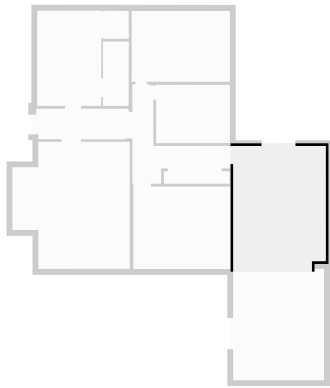

Property Directions. THIS FLOORPLAN IS PROVIDED WITHOUT WARRANTY OF ANY KIND. SENSOPIA DISCLAIMS ANY WARRANTY INCLUDING, WITHOUT LIMITATION, SATISFACTORY QUALITY OR ACCURACY OF DIMENSIONS. Property Directions.

Dining Room

Width: 12' 8 3/4"
 Length: 15' 2 1/2"
 Area: 193.75 sq ft
 Perimeter: 55' 10 3/4"
 Ceiling Height: 7' 10 1/2"

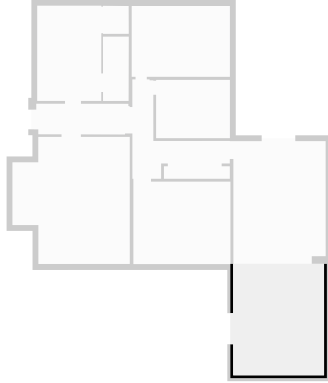
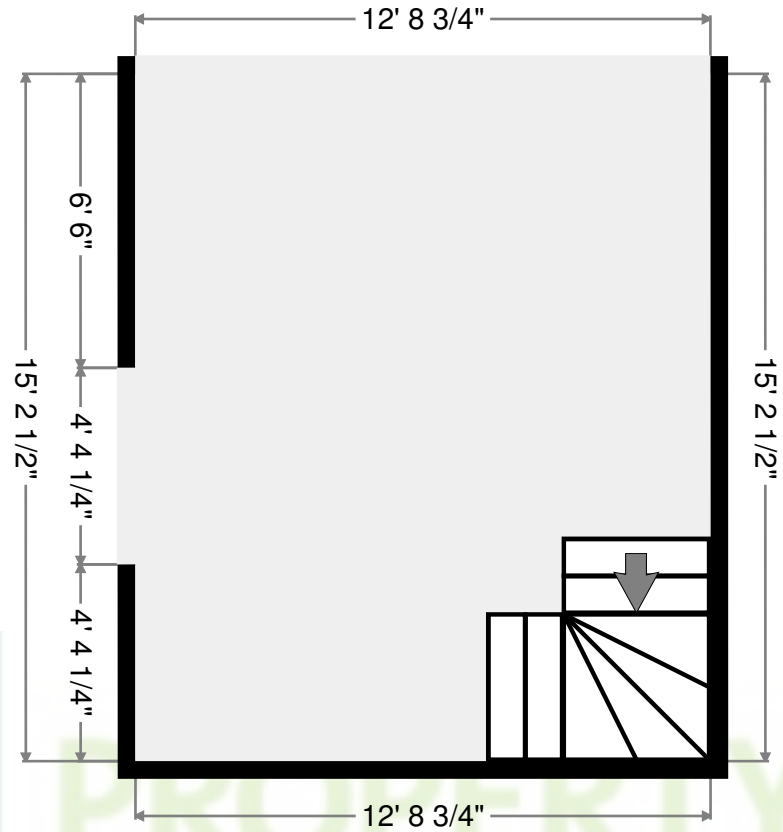

Closet

Width: 1' 9"
 Length: 9' 2 3/4"
 Area: 16.11 sq ft
 Perimeter: 21' 11 1/2"

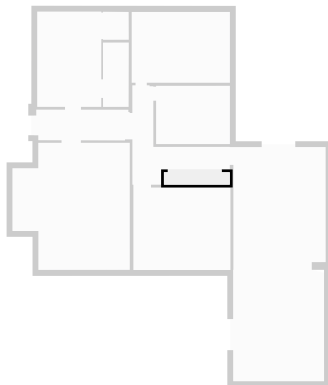
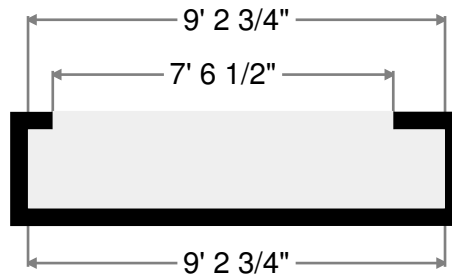

Property Directions. THIS FLOORPLAN IS PROVIDED WITHOUT WARRANTY OF ANY KIND. SENSOPIA DISCLAIMS ANY WARRANTY INCLUDING, WITHOUT LIMITATION, SATISFACTORY QUALITY OR ACCURACY OF DIMENSIONS. Property Directions.

Closet

Width: 3' 7"
 Length: 3' 11 1/4"
 Area: 14.08 sq ft
 Perimeter: 15' 1/4"

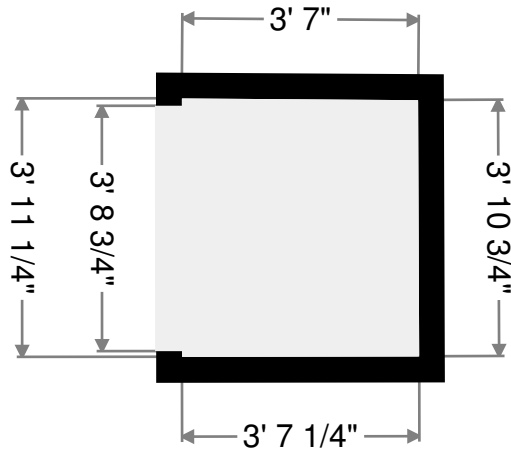
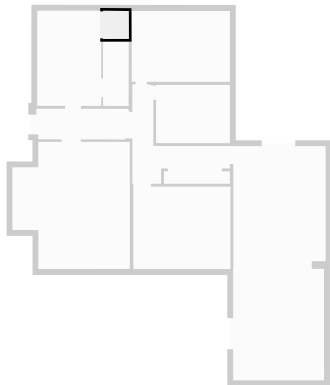

Bathroom

Width: 3' 7 1/2"
 Length: 9'
 Area: 32.45 sq ft
 Perimeter: 25' 2 3/4"

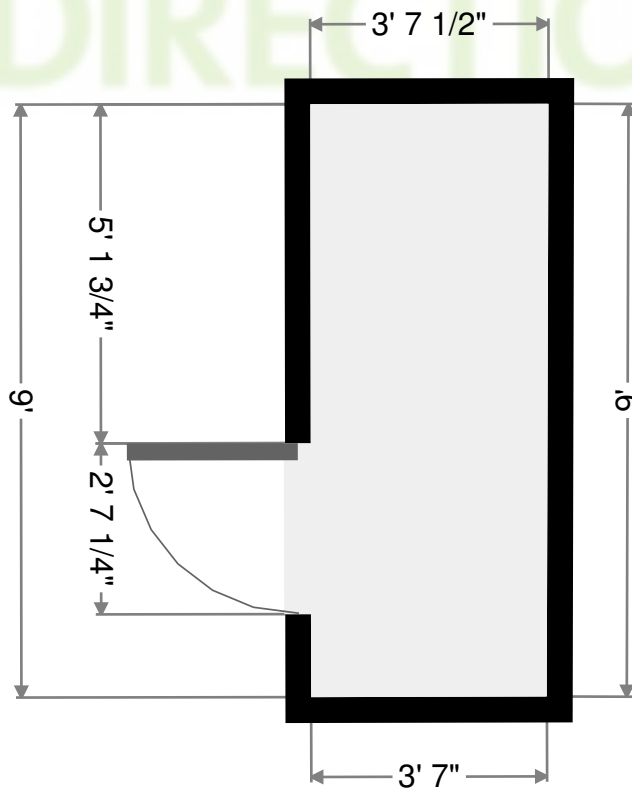
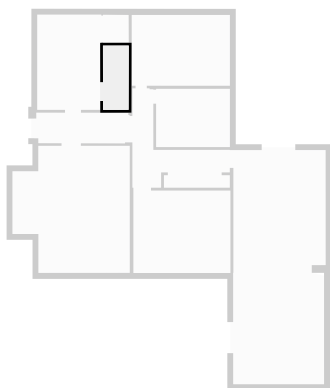

PROPERTY DIRECTIONS

Property Directions.
 THIS FLOORPLAN IS PROVIDED WITHOUT WARRANTY OF ANY KIND. SENSOPIA DISCLAIMS ANY WARRANTY INCLUDING, WITHOUT LIMITATION, SATISFACTORY QUALITY OR ACCURACY OF DIMENSIONS.
 Property Directions.

1st Floor

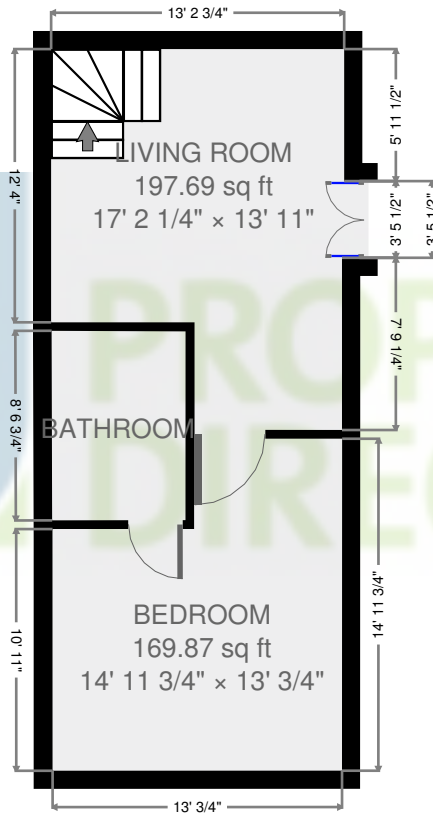

PROPERTY DIRECTIONS

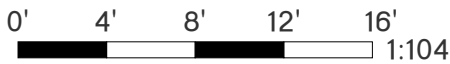

16 Shimna Road, Newcastle, BT33 0AT

2016-03-16

1786 sq ft
2 Floors
13 Rooms
4 Bedrooms
3 Bathrooms

Property Directions.
THIS FLOORPLAN IS PROVIDED WITHOUT WARRANTY OF ANY KIND. SENSOPIA DISCLAIMS ANY WARRANTY INCLUDING, WITHOUT LIMITATION, SATISFACTORY QUALITY OR ACCURACY OF DIMENSIONS.
Property Directions.

Living Room

Width: 13' 11"
 Length: 17' 2 1/4"
 Area: 197.69 sq ft
 Perimeter: 62' 3"
 Ceiling Height: 8' 9 3/4"

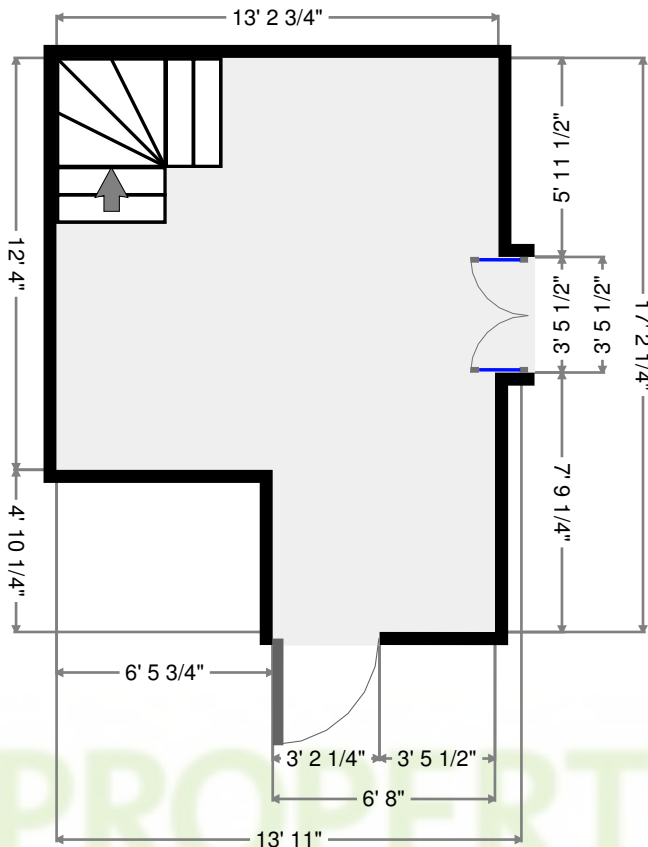
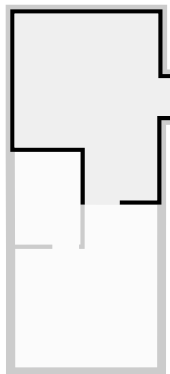

Bedroom

Width: 13' 3/4"
 Length: 14' 11 3/4"
 Area: 169.87 sq ft
 Perimeter: 56' 1 1/2"
 Ceiling Height: 8' 9 3/4"

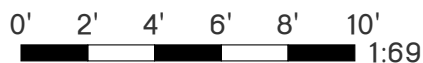
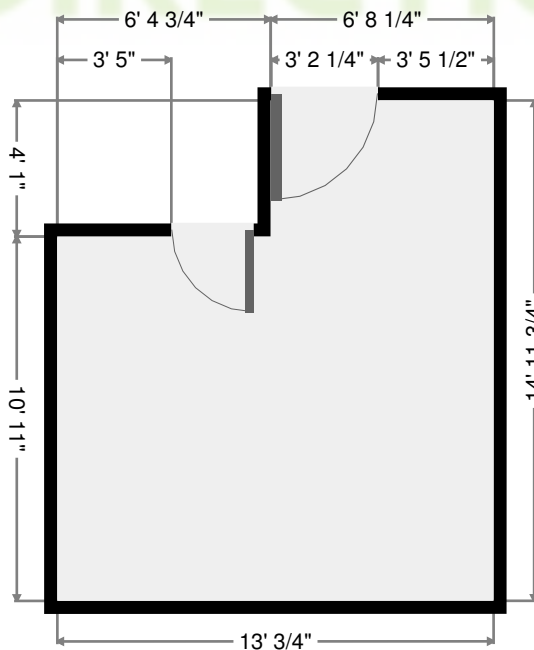
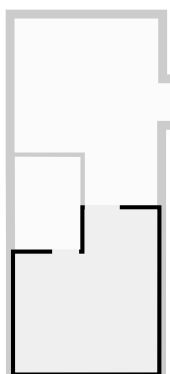

Property Directions. THIS FLOORPLAN IS PROVIDED WITHOUT WARRANTY OF ANY KIND. SENSOPIA DISCLAIMS ANY WARRANTY INCLUDING, WITHOUT LIMITATION, SATISFACTORY QUALITY OR ACCURACY OF DIMENSIONS. Property Directions.

Bathroom

Width: 6' 1/4"
Length: 8' 6 3/4"
Area: 51.54 sq ft
Perimeter: 29' 1 3/4"

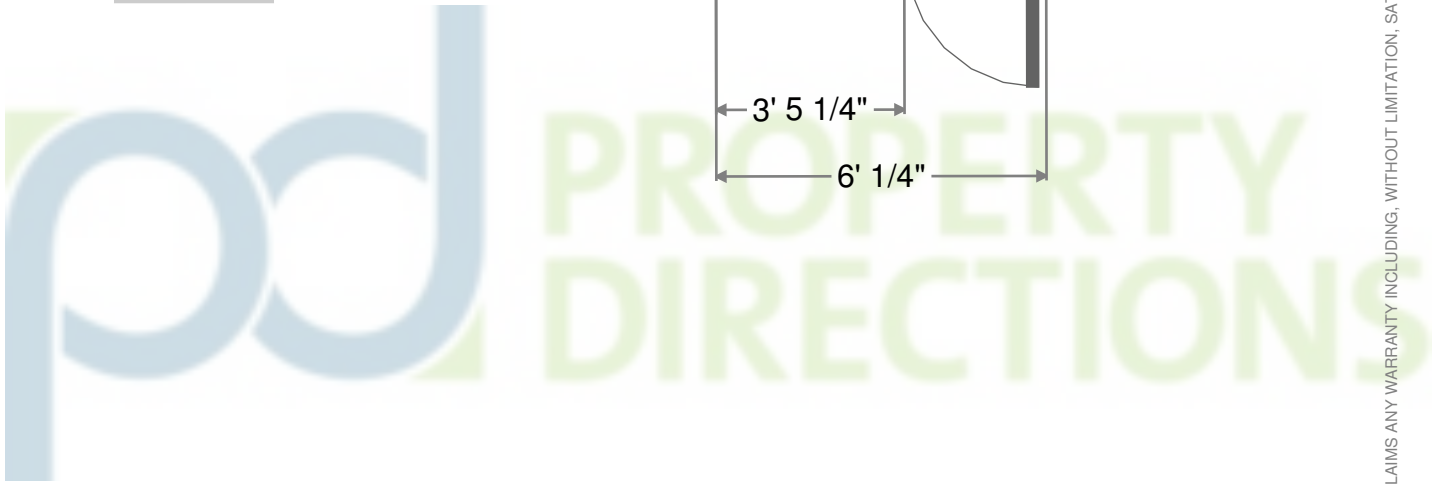
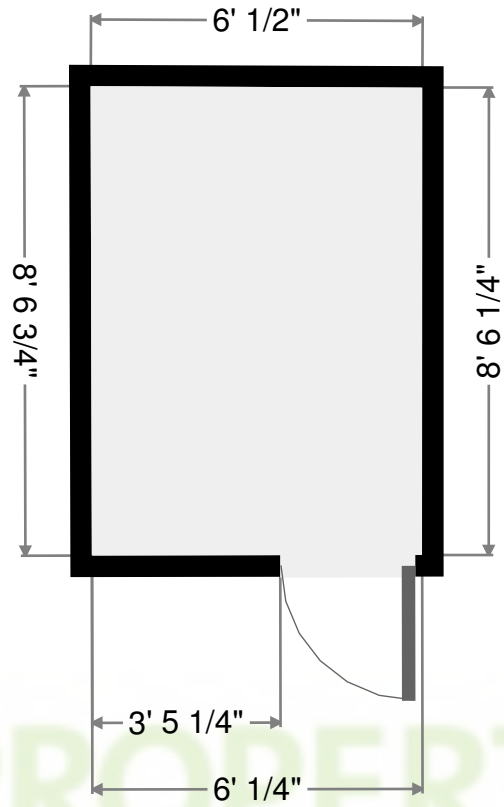
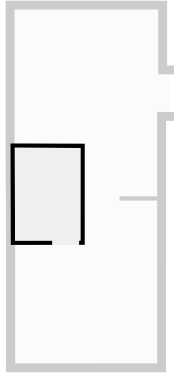

Property Directions.
THIS FLOORPLAN IS PROVIDED WITHOUT WARRANTY OF ANY KIND. SENSOPIA DISCLAIMS ANY WARRANTY INCLUDING, WITHOUT LIMITATION, SATISFACTORY QUALITY OR ACCURACY OF DIMENSIONS.
Property Directions.